

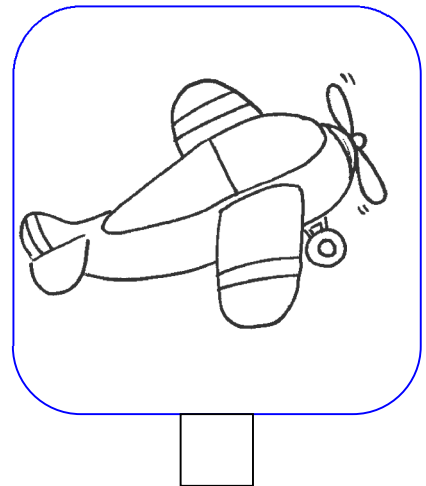

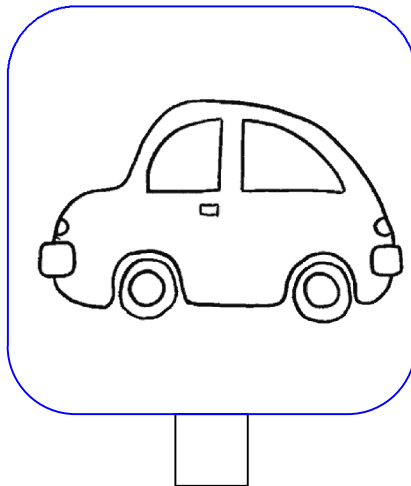

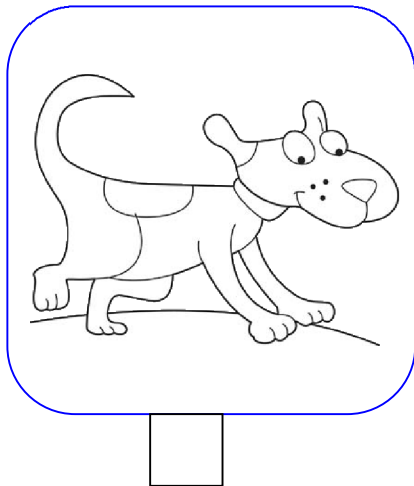

 Indica con una **x** solo le figure i cui nomi **iniziano** con la vocale **A**.

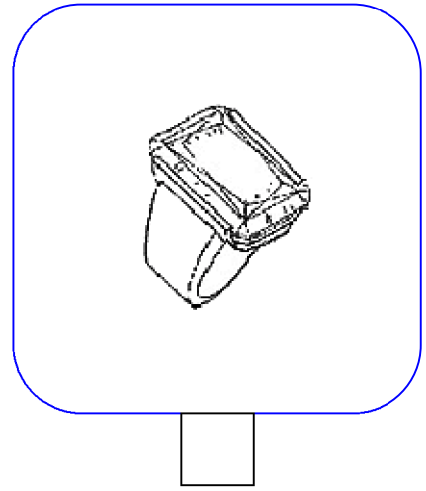
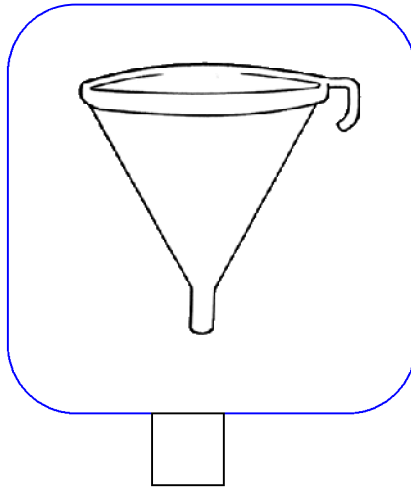
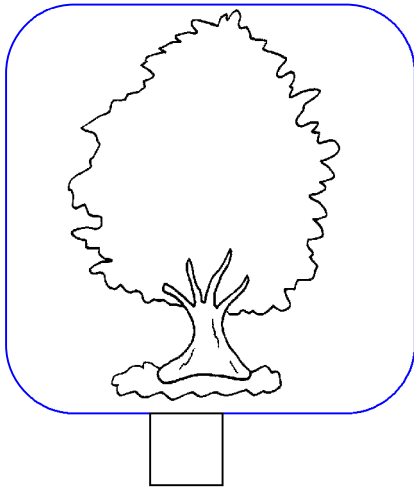

 Circonda la lettera **A** nelle parole.

**AGO**      **APE**      **PANE**      **ARPA**  
**ANGURIA**      **AMICA**      **ANANAS**

 Ora prova nei righi

 Indica con una **x** solo le figure i cui nomi **finiscono** con la vocale **A**.

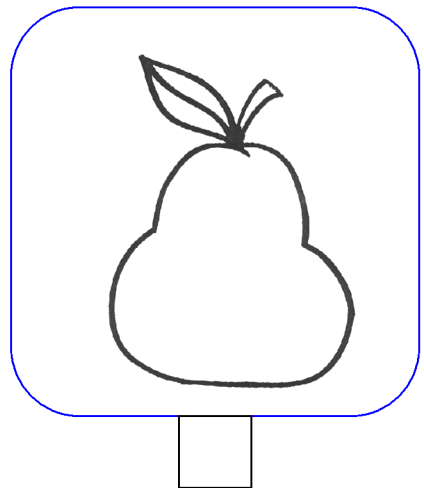
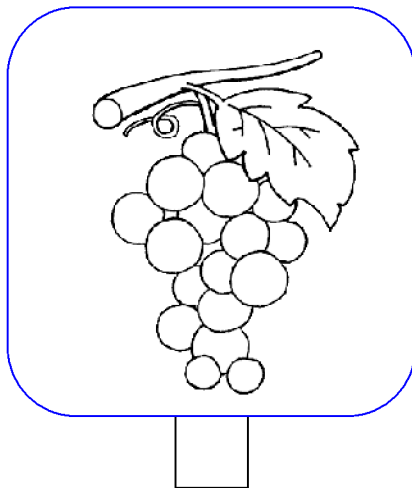
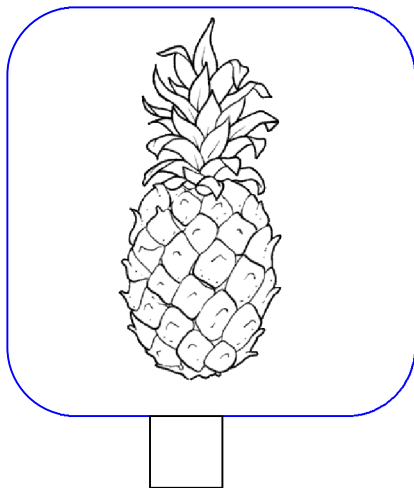
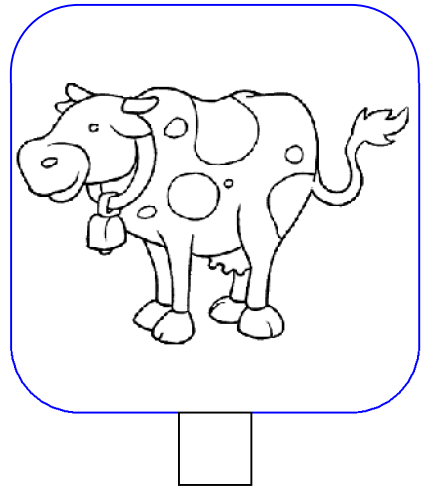
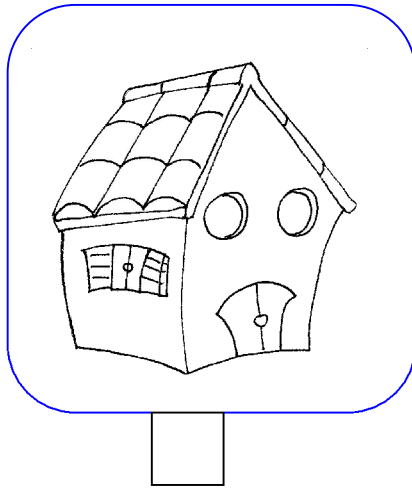
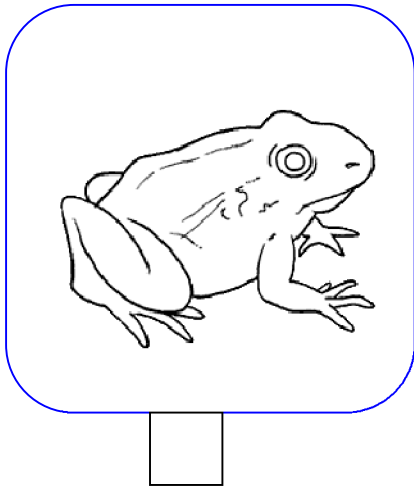

 Completa con **A** dove manca.

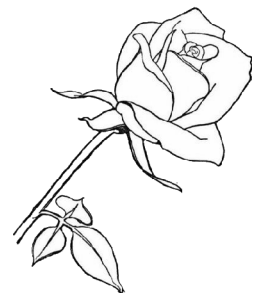
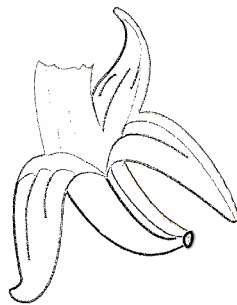

B		N	N	
---	--	---	---	--

R	O	S	
---	---	---	--

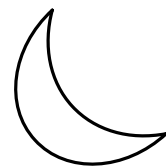
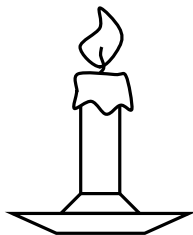

C		N	D	E	L	
---	--	---	---	---	---	--

L	U	N	
---	---	---	--